

6-14-2013

Amperometric detection of bioamines in cancer borealis using microchip capillary electrophoresis integrated with micellar chromatography

Ajay Fernandez
Santa Clara Univeristy

Jason Howard
Santa Clara Univeristy

Christina Shuh
Santa Clara Univeristy

Follow this and additional works at: http://scholarcommons.scu.edu/bioe_senior

 Part of the [Biomedical Engineering and Bioengineering Commons](#)

Recommended Citation

Fernandez, Ajay; Howard, Jason; and Shuh, Christina, "Amperometric detection of bioamines in cancer borealis using microchip capillary electrophoresis integrated with micellar chromatography" (2013). *Bioengineering Senior Theses*. 4.
http://scholarcommons.scu.edu/bioe_senior/4

This Thesis is brought to you for free and open access by the Engineering Senior Theses at Scholar Commons. It has been accepted for inclusion in Bioengineering Senior Theses by an authorized administrator of Scholar Commons. For more information, please contact rsroggin@scu.edu.

SANTA CLARA UNIVERSITY
DEPARTMENT OF BIOENGINEERING

Date: June 14, 2013

I HEREBY RECOMMEND THAT THE THESIS PREPARED UNDER MY SUPERVISION BY

Ajay Fernandez, Jason Howard, Christina Shuh

ENTITLED

**Amperometric Detection of Bioamines in *Cancer borealis* Using
Microchip Capillary Electrophoresis Integrated with Micellar
Chromatography**

BE ACCEPTED IN PARTIAL FULFILLMENT OF THE REQUIREMENTS FOR THE DEGREE OF

BACHELOR OF SCIENCE IN BIOENGINEERING

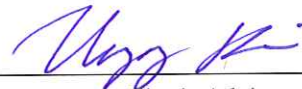

Thesis Advisor



Department Chair

**Amperometric Detection of Bioamines in *Cancer borealis* Using
Microchip Capillary Electrophoresis Integrated with Micellar
Chromatography**

by

Ajay Fernandez, Jason Howard, Christina Shuh

Submitted in partial fulfillment of the requirements
for the degree of
Bachelor of Science in Bioengineering
School of Engineering
Santa Clara University

Santa Clara, California
June 14, 2013

Amperometric Detection of Bioamines in *Cancer borealis* Using Microchip Capillary Electrophoresis Integrated with Micellar Chromatography

Ajay Fernandez, Jason Howard, Christina Shuh

Department of Bioengineering
Santa Clara University
June 14, 2013

ABSTRACT

In order to study neuromodulation in *Cancer borealis*, commonly known as the Jonah crab, we designed a microchip capillary electrophoretic (CE) device with micellar electrokinetic chromatography (MEKC) to separate bioamines and detect their concentrations using amperometric detection (AD). The analysis will be used to characterize the bioamines: dopamine, octopamine, tyramine, serotonin, norepinephrine, and gamma-aminobutyric acid (GABA). The device measures the concentration of bioamines in microdialysate samples taken directly from the pericardial cavity of the crab. The research on Jonah crabs will be applied to enhance our understanding of the crab neurology. Since the structure and in some instances, the function of the neuromodulators are conserved, this research may be applicable to human studies. Researchers who use our device will be able to detect nanomolar concentrations of bioamines. This will help them to better understand the nervous system of crabs. This could also lead to a better understanding of the human nervous system and how to treat and manage neurodegenerative diseases.

In order to obtain data, the device incorporates carbon paste electrodes modified with carbon nanotubes, which literature suggests should be able to detect 50 nanomolar concentrations using amperometry. Moreover, the buffer solution includes sodium dodecyl sulfate (SDS) micelles to separate two structural isomers of interest - octopamine and dopamine - by their difference in affinity. Combining these methods and applying voltage across the long channel separates bioamines via electroosmotic flow (EOF) based on their electrophoretic mobility. At the end of the CE channel there are electrodes to measure bioamine concentration via AD.

An SU-8 mold was prepared by standard lithography techniques. Polydimethylsiloxane (PDMS) channels were formed from an SU-8 mold through replica molding. Carbon paste electrodes were screen printed into the PDMS electrode channel. We observed electroosmotic flow in CE by inserting fluorescein isothiocyanate (FITC)-dextran dye and applying high voltage. Electrodes were placed in channel near the outlet to electrochemically detect the concentration of each bioamine. The limit of detection (LOD) for carbon paste electrodes was observed to be 10 nM using Cyclic Voltammetry (CV). Our device provides low cost fabrication, high time resolution, high sensitivity, and multi-analyte detection of bioamines in *Cancer borealis*.

Acknowledgements

We would like to thank our Bioengineering advisor Dr. Ashley Kim for her guidance throughout the project. We would also like to thank our collaborating professors Dr. Steven Suljak (Chemistry), and Dr. John Birmingham (Physics) for their assistance. Additionally, we would like to thank Dr. Paul Abbyad (Chemistry) for allowing us to use his facilities and equipment. We are very grateful for our funding from the Santa Clara School of Engineering. Furthermore, we would like to thank Stanford University and San Jose State University for use of their facilities and equipment. We would also like to thank our lab managers Gregory Laskowski and Blanca Silva.

Table of Contents

Acceptance Statement	i
Title Page	ii
Abstract	iii
Acknowledgments	iv
Table of Contents	vi
List of Figures	vii
List of Tables	viii
1 Introduction	1
2 System	3
2.1 System Overview	3
2.2 Device Overview	4
2.3 Customer Needs	4
2.4 Benchmarking	6
2.5 Functional Analysis	6
2.6 System Issues, Options, and Tradeoffs	7
2.7 Subcomponents	8
2.8 Team and Project Management	9
3 Subsystems	10
3.1 Chemical Analyzer	10
3.2 Voltage Source	10
3.3 Syringe Pump	11
4 System Integration	12
4.1 Photolithography	12
4.2 PDMS Base	13
4.3 Carbon Paste Electrodes	13
4.4 Bonding	14
4.5 Additional Components	14
4.6 Testing Results	15
4.6.1 Fluid Control	15
4.6.2 Cyclic Voltammetry	15
4.6.3 Amperometric Detection	16
5 Cost Analysis	17

6 Publishing Plan	18
7 Engineering Standards and Realistic Constraints	19
8 Summary and Conclusions	20
9 Bibliography	21
Appendices	23
A Interviews	24
B Solidworks Designs	26
C Budget	28
D Procedure	29
E Schedule	32

List of Figures

2.1	System Overview	3
2.2	Device Overview	4
2.3	Fabricated Prototype	4
2.4	Micelle Separation	7
3.1	Electroosmotic Flow	11
4.1	Photolithography	12
4.2	PDMS Base	13
4.3	Electrode Fabrication	14
4.4	Fluid Control	15
4.5	Cyclic Voltammetry	16
4.6	Amperometric Test	16
B.1	Solidworks Design 1	26
B.2	Solidworks Design 2	27
B.3	Solidworks Design 3	27

List of Tables

2.1	Customer Needs	4
2.2	Benchmarks	6
2.3	Device Requirements	7
2.4	Team Walk Aways	9
A.1	Kim Interview	24
A.2	Suljak Interview	24
A.3	Birmingham Interview	25
C.1	Budget	28
E.1	Fall 2012	32
E.2	Winter 2013	32
E.3	Spring 2013	32

Chapter 1

Introduction

Our group developed a microfluidic device to enhance separation and detection of bioamines. This will help our collaborators, Dr. John Birmingham in the Physics Department and Dr. Steven Suljak in the Chemistry Department, research the effects of neuromodulation in the Cancer borealis crab, also known as the Jonah crab. In order for the Physics and Chemistry Departments to study neuromodulation, they must be able to detect physiological concentrations ranging in the nanomolar concentrations. Currently available technology does not allow the researchers to detect nanomolar concentrations of bioamines in addition to being expensive. The bioamines of interest are: gamma amino-butyric acid (GABA; MW 103), dopamine (MW 154), octopamine (MW 154), tyramine (MW 137), norepinephrine (MW 169), and serotonin (MW 176). Detected concentrations can be correlated with corresponding effects allowing for characterization of those neuromodulators and the development of neurologic models. After obtaining and forming models, there may be a chance that the information and instruments may apply to human neurology.¹ This could lead to a better understanding of the human nervous system allowing for better treatment of neurodegenerative diseases. The microfluidic device was made from Poly[dimethylsiloxane] (PDMS) and followed an off-channel configuration of capillary electrophoresis (CE) incorporating micellar electrokinetic chromatography (MEKC). CE was used as a means to separate bioamines based on charge and size due to the applied electrical potential. In the off-channel configuration, the potential was applied across the separation channel and grounded by a palladium (Pd) decoupler, which lay three hundred micrometers above the detection electrode (see figure 1).^{2,3,4,5} In addition, the negative charge on the surface of the channels created electroosmotic flow, which created a bulk flow toward the end waste channel, overcoming charge repulsion from the applied potential. This ensured that the analyte moved toward the sensor and not back into the inlets. Microchip CE was advantageous because it used small amounts of analyte coupled with fast run times. Despite these advantages, Dopamine and Octopamine are structural isomers, meaning they did not separate by electrophoresis alone. As a result, MEKC was incorporated to separate dopamine and octopamine by their difference in affinity to

sodium dodecyl sulphate (SDS) micelles. The novelty in our device comes from the combination of all the technologies described above being used to investigate and quantify a biological sample.

Chapter 2

System

2.1 System Overview

Several different technologies were incorporated into our device. The technologies were chosen based on customer needs and the nature of the technology will be discussed further in the paper. The device was fabricated from polydimethylsiloxane (PDMS) and had a carbon paste sensor to detect the bioamines. Micellar electrokinetic chromatography (MEKC) was used to separate octopamine and dopamine. Capillary electrophoresis drove the solution through the device allowing for detection of the concentrations of bioamines in the samples obtained from the crab. The integration of the combined technology is illustrated in Figure 2.1 below.

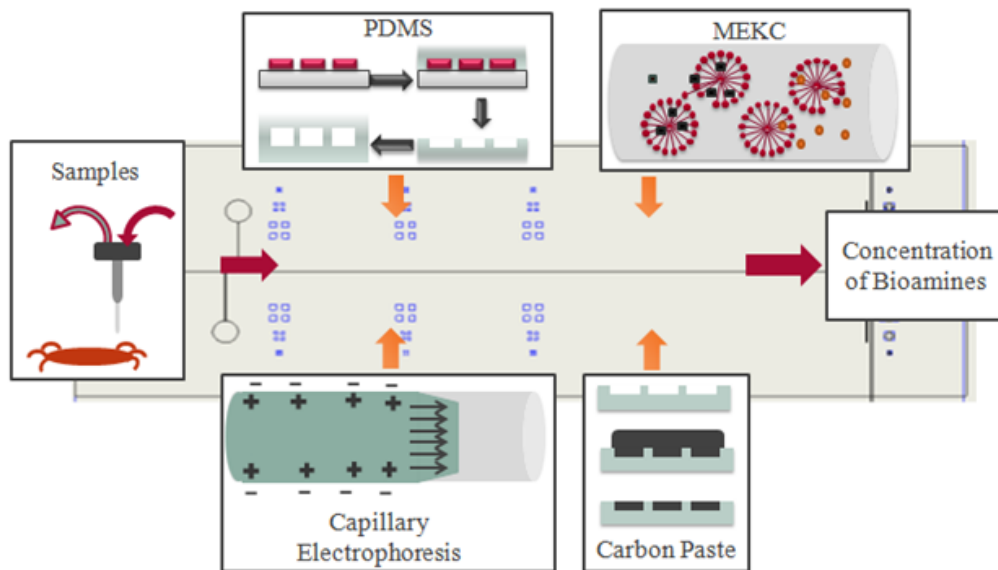

Figure 2.1: System Overview

2.2 Device Overview

The specific features of the device were carefully chosen based on previous research done on microfluidic devices. The figure below gives a schematic of the features in the device. Each of the features will be discussed throughout the paper. A fabricated prototype is also displayed next to a penny. This figure really captures how small the device is in reality.

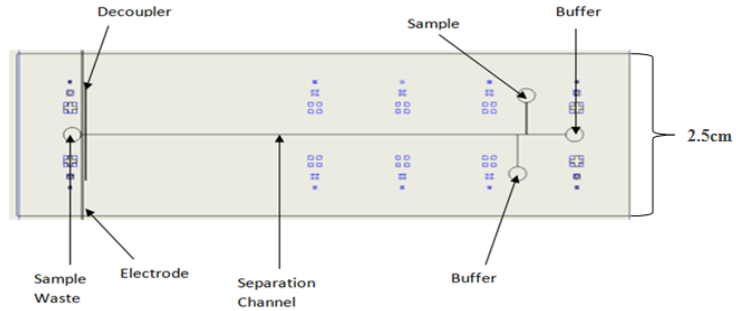

Figure 2.2: Device overview



Figure 2.3: Fabricated prototype

2.3 Customer Needs

Since our product was intended for the research conducted by Birmingham and Suljak, we interviewed them in order to better understand the issue. After conducting interviews with Kim, Suljak, and Birmingham, we were able to identify the design needs of our project as detailed in Table 2.1.

Need	Specification
1) Mid-nanomolar Detection Limits	Use AD with nanotube enhanced carbon paste electrodes
2) Separation of Isomers	Include MEKC
3) Small Sample Size	Use microchip platform
4) Long Lifespan/ Cost-Effective	Use silicon for the base and carbon paste for the electrodes to decrease cost. Also, the device will be multiple use

Table 2.1: Customer specified needs in order of importance

Considering the customer requirements specified in Table 2.1, the design according to Figure 2.1 was the most appropriate. One of the key elements of the device was increasing the sensitivity of our device in comparison to current techniques. Achieving nanomolar detection capabilities enabled our collaborators to detect the bioamines of interest in physiological concentrations to further their research. After researching current methods, we decided to achieve this by adding multi-walled carbon nanotubes (MWCNTs) to our carbon paste electrode.

According to Sameenoi, after adding MWCNTs, the limit of detection (LOD) for catecholamines (namely dopamine) improved tenfold (from 500 nM to 50 nM), which was necessary to detect the concentrations of interest.⁶ The authors believed that adding carbon nanotubes increased the surface area of the electrode, making it more sensitive. Obtaining nanomolar concentration detection was a key requirement of our device, but for the device to fully meet their needs, it also needed to incorporate other methods.

Another key aspect of the device required the separation of the two isomers of interest. In the Jonah crab, the isomers, octopamine and dopamine, perform different biological functions, but does not separate due to CE since they are the same charge and size. Knowing the concentration of each is crucial to understanding the physiological response of the crab. In order to combat the isomeric nature of dopamine and octopamine, we used sodium dodecyl sulfate (SDS) micelles in the buffer solution. The micelles separate the isomers by the difference in affinity each isomer has towards the micelles (see Figure 2.4.)^{7,8,9} Note that octopamine (orange circles) has less affinity for the micelles and eluted before dopamine (black squares). This allowed us to see two different peaks in the results; octopamine and then dopamine.

After separating the two isomers, the next customer need required smaller sample sizes in order to preserve analyte, as well as, to obtain more time sensitive data. As such, a microchip device platform was implemented. This allowed the device to process samples requiring only nanoliters of solutions, which was especially useful because the samples came directly from the crabs pericardial cavity. Consequently, it was advantageous to remove less fluid for crab longevity. Moreover, since the extraction method was microdialysis, smaller volumes correlate to smaller amounts of time and thus more indicative of instantaneous responses to stimuli.

After establishing the full functionality of the device, the customers requested that the device be cost effective and reusable. To meet these requests we fabricated our device out of PDMS, which is a non-toxic, inert, and flexible plastic. PDMS was inexpensive and can be used repeatedly. We also used carbon paste electrodes that interact favorably with bio-solutions and did not lose their sensitivity as readily as traditional metal electrodes. Moreover, carbon paste was easy to fabricate and inexpensive.

2.4 Benchmarking

After defining the parameters of the device, we researched several contemporary methods. Consequently, we made certain goals or benchmarks that we hoped to accomplish and compare to other available technologies. The table below presented current instruments and brief information about their specifications.

Model (type of device)	Specifications	Manufacturer	Capabilities	Limitations	Cost
LCQ Fleet (LC/MS)	ESI source; Ion Trap Analyzer	Thermo Scientific	Able to ID molecules easily due to MS; mid micromolar range	Sample Size; Detection Limits	\$100,000
MDQ (CE w/ MEKC)	SDS micelles; Absorbance Detection	Beckmann Coulter	Simple; low micromolar range	Sample Size; Detection Limits	\$100,000

Table 2.2: Benchmarks as described and used by Suljak and laboratory

As aforementioned, our microchip provided the specifications enumerated in the customer needs section. Ideally, our device was similar to the MDQ (CE with MEKC) since we fabricated a miniature version using similar methods (except the method of detection). However, our device will reach a lower LOD, ideally nanomolar detection, and used much smaller sample sizes.

2.5 Functional Analysis

After adequate background and research on other technology and customer needs, we created solutions to meet benchmarks and customer needs. The table below relates the goal, the technology used, and why we chose this technology.

Requirement	Solution	Explanation
Nanomolar Concentration Detection	Carbon nanotube modified carbon paste electrode	Adding nanotubes to the carbon paste electrode will increase surface area allowing for greater sensitivity to molecules.
Biocompatible Electrode	Carbon paste	The carbon paste electrode does not foul or allow biological material to build up increasing longevity.
Separate Isomers: Octopamine and Dopamine	MEKC	Micelles allow isomers to interact with the polar head and non polar tail groups, allowing separation based on the molecules affinity to the micelles
Cost Effective	PDMS, carbon paste, and microchip platform	PDMS and carbon paste is inexpensive to fabricate

Requirement	Solution	Explanation
Multiuse	Carbon paste electrode	Since the carbon paste electrode does not foul with biological material it can be used many times before needing to be replaced

Table 2.3: Device Requirements

Based on the different components we have three main systems. The first system is the device system, which includes the PDMS used to make the device. It is important in this system to achieve the correct consistency of PDMS by combining the appropriate ratio of base and agent. The function of this system is to provide the structure for the device. The main trade off is a cost to stability issue. The more PDMS used the more stable the device becomes, but this increased cost. We chose an optimum 22 grams for each wafer, which offered a balance in cost and stability. Those 22 grams were made from a 10:1 ratio of base:agent. This ratio gave the correct consistency of the PDMS and could easily be cured in the oven. The second is the electrode system, which is the carbon paste sensor with modifications. Adding modifications to the carbon sensor, such as carbon nanotubes, helped increase the sensitivity. Carbon paste was chosen because it works well with biological media and is inexpensive compared to other common electrode materials. These combined allowed the device to be reusable and cost effective. The third system is the testing system, which includes the MEKC to separate octopamine and dopamine. MEKC works to separate the two amines using difference in their affinities to the micelles. The micelles have a polar head group and a non polar tail. Octopamine and dopamine had different affinities for these micelles so they passed over the electrode at different times, thus allowing us to see the two different peaks on the chemical analyzer.

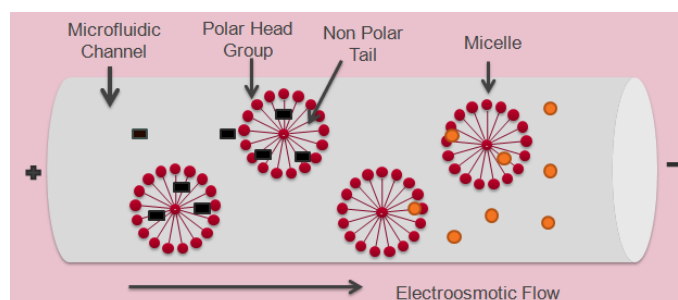

Figure 2.4: Micellar separation of octopamine and dopamine

2.6 System Issues, Options, and Tradeoffs

One of the major system issues on the front end was the SU-8 master molds that we used to form the base of the device. Since the molds were fabricated by the Stanford Microfluidics Foundry, there was a time delay of about three to five weeks after the molds were ordered. Unfortunately, the molds could break or

otherwise deteriorate due to repeated use. The master molds could also be damaged by improper curing of the PDMS. Additionally, as mentioned in the previous section, our device aimed to achieve nanomolar detection limits. Due to the device's application with biological media, carbon paste seemed more applicable as an electrode material. Traditional electrodes foul - when biological media conglomerate on the surface of the electrode or otherwise reduced its ability to conduct - and as such were not applicable analyzing solutions with bioamines. However, carbon paste is less sensitive than traditional metal electrodes such as gold or platinum.^{6,10} Additionally, the creation of a microchip meant that our system required less analyte, but was harder to create and design, as well as more difficult to achieve accurate, consistent, and low detection limits. One of the greatest fabrication challenges we faced was plasma bonding. Since PDMS to PDMS bonding tends to be weaker than alternatives such as PDMS to glass, bonding was difficult. Moreover, due to the method of screen printing electrodes, the surface was exposed to small particulates that easily collect on the surface leading to further decreased bonding strength. Keeping the molds on the wafer until placement in the plasma cleaner helped keep the PDMS clean. Using scotch tape to clean the surface helped create a stronger bond.

2.7 Subcomponents

Options and tradeoffs Although the device is one system, it can be split into top and bottom layers, see appendix B for the SolidWorks 2012 designs. The top layer consisted of the PDMS mold with an imprint of the channel. The top layer also has the inlet reservoirs (2 mm diameter circles) allowing buffer and analyte solutions to run through the channels. The device allows for 1 mm offset between the t-section of the analyte inlet and waste reservoirs. The separation channel was 5 cm, which was enough distance to separate the solution into bands of analyte - where band refers to a high concentration of analyte in a small width, ideally infinitely small. Although the length could be longer to ensure separation, that would require a higher potential and more heat would be created as well as bubbles creating unnecessary problems. Moreover, longer separation channels led to increased band broadening, which lowers the time resolution. Alternatively, a shorter separation channel means that the analyte will not separate as well, but requires less potential and has a lower chance to create bubbles. The bottom layer, 50 μm depth, consists of a decoupler and an electrode channel. The first feature was a guiding channel for the decoupler, 100 μm wide. The decoupler is a Pd wire that acts as a ground for the applied potential from the potential required for CE. The next feature, 300 μm downstream from the decoupler, is the carbon paste electrode. The channel for the carbon paste electrode is 250 μm wide and was positioned 750 μm from the end to allow for error in placement. The decoupler was included with the electrode in order to ensure an exact distance of 300 μm for the potential to dissipate.

Although there were conflicting views, several similar devices used 250 μm , we chose 300 μm to counter the possibility that 250 μm was too short.^{2,3,4}

2.8 Team and Project Management

While testing and results were important, there was also an ethical obligation that engineers should uphold in case there were issues. The key starting place for ensuring an ethical senior design project was to form a strong bond between team members and advisors. Maintaining respectful relationships between all individuals involved was extremely crucial to the success of the project. To enable adequate communication between members, we scheduled weekly meetings where we discussed all project issues whether they were technical, personal, or ethical. This created an environment where all individuals felt comfortable expressing their concerns and opinions. This also helped to make sure all members were treated fairly and appropriately. We identified three major “Walk Aways” if members became concerned with the conflicts between others or the project:

Nature	Walk Away
Personal Dignity	When dignity and respect for an individual on the team is denied without resolution
Technical Integrity	When forced to forge data or make a device that does not promote ethical research
Safety	When an individuals well-being is jeopardized.

Table 2.4: Team Walk Aways

Chapter 3

Subsystems

3.1 Chemical Analyzer

The chemical analyzer provided the detection monitoring system. We chose two main techniques to work with. The preliminary technique was cyclic voltammetry. In this process a sweeping voltage is applied from a specified range. The sweeps can occur repeatedly for as many times as needed for the user. This was only used as a preliminary test to help determine the functionality of our carbon paste electrode. Cyclic voltammetry was useful because the device does not need to have a secondary voltage source and does not require electroosmotic flow to function. The main limitation is that this technique does not achieve the sensitivity that our customers desire. To achieve the desired sensitivity, amperometric detection was used. Amperometric detection measures the current output with respect to time. This is a much more sensitive technique, but requires electroactive analyte and electroosmotic flow

3.2 Voltage Source

To generate the movement of samples through our device we used a voltage source. This voltage source applied electricity to the system, which in turn generates electroosmotic flow. Electroosmotic flow causes the movement of the amines with a trapezoid like profile. The amines separate based on charge because of the voltage. Positive molecules moved first, followed by neutral atoms and lastly by negative molecules. The significance of the trapezoidal profile is that it provided better time resolution, which was crucial to our customer.

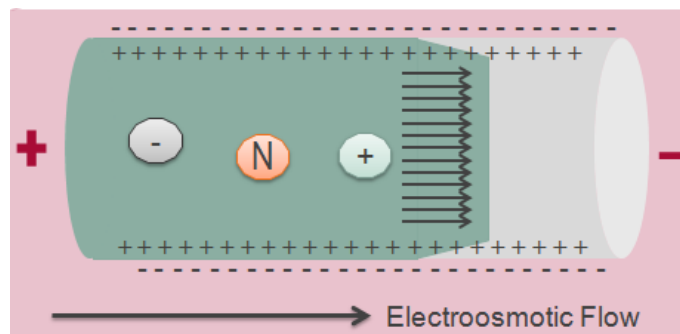

Figure 3.1: Electroosmotic flow

3.3 Syringe Pump

The syringe pump enabled us to load the device with desired solutions. We placed a syringe with tubing connected the device. We then set the desired flow rate. We generally ran 50 micro liters per min. This was to make sure as not to place too much stress on the device and break the bonding. The act of loading the device with solution prepares the device for electroosmotic flow. The syringe pump was also valuable during preliminary testing with cyclic voltammetry.

Chapter 4

System Integration

Our device was manufactured using Santa Clara University facilities and did not require integration of any pre-made products besides manufactured metal electrodes and the master molds from Stanford Microfluidics Foundry. The procedure is as follows:

4.1 Photolithography

The master molds were fabricated by Stanford University Microfluidics Foundry via photolithography. The master molds were made using negative SU-8 photoresist (refer to Figure 3 below for graphic details). SU-8 is epoxy-based and when it was exposed to UV light, it begins to polymerize. After exposure to the UV light, the mold was placed in a solvent that removed unexposed areas while leaving areas exposed to the UV light. In order to control the UV light exposure, a mask was placed that absorbs UV light in areas that should be removed.¹¹

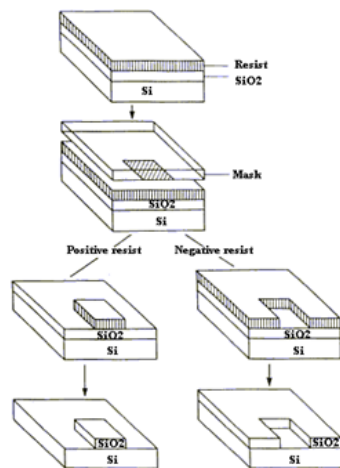

Figure 4.1: Photolithography

4.2 PDMS Base

In order to create our PDMS device we used the Dow Corning Sylgard 184 Silicone Elastomer Kit. It is a two part kit that polymerizes upon contact in a 10:1 ratio by weight of base:curing agent. Once the two components were mixed thoroughly, the silicon was degassed for an hour to ensure that no air bubbles developed in the PDMS device. After degassing, the mix was poured on the master molds and placed in an oven set at 75 C. The polymer cured for a minimum of 2 hours at this temperature. The elevated temperature decreased the curing time of PDMS (curing in ambient temperature takes about a day to cure).

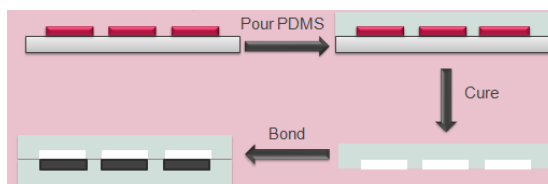

Figure 4.2: PDMS Base

4.3 Carbon Paste Electrodes

Once the PDMS cured, the carbon paste electrodes were fabricated. We used mineral oil and graphite powder (donated by the chemistry department), carbon nanotubes, and Sylgard 184 PDMS kit. First, the mineral oil and PDMS were mixed in a 1:1 ratio by weight; this component is referred to as the binder. Followed by the graphite powder and carbon nanotubes in a 1:1 ratio by weight; referred to as the electroactive component. Then, mixed the binder and electroactive component in a 1:1 ratio by weight until uniform (however, double the amount of binder was created in order to adequately compensate for the binder lost when mixing with the electroactive component). Once mixed thoroughly, we covered the electrode PDMS layer until only the electrode imprint was exposed (and the decoupler imprint was covered). The carbon paste created in the previous protocol, was screen printed across the channel with even pressure. Remove the tape that was covering the adjacent area leaving slight excess surrounding the electrode. Thus, we removed the excess by applying scotch tape until the carbon paste was only in the electrode imprint. Then cure the electrode for one hour at 120 C.

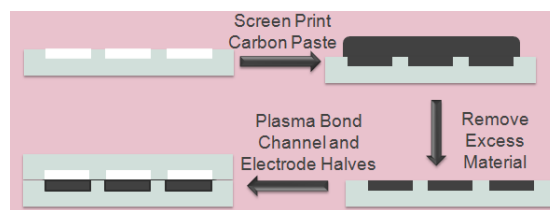

Figure 4.3: Electrode fabrication

4.4 Bonding

In order to bond the layers of PDMS together, we used a plasma bonder, which cleaned and activated the hydroxyl groups on the surface allowing covalent attachment. The procedure was developed using a Harrick Plasma Cleaner model PDC 001. After placing the PDMS in the chamber, the chamber was purged by degassing to 400 mtorr and allowing the pressure to steadily rise to 750 mtorr. When the pressure reached 750 mtorr, the PDMS was exposed for 15 seconds in the gas chamber at the medium setting. Then, the PDMS was removed from the chamber and attached together allowing the carbon paste electrode to protrude to one side to allow adequate room for attachment. In order to complete the electrical connection to the carbon paste to allow for amperometric detection, we applied silver paint to the top of the electrode while attaching copper wiring that led to the chemical analyzer.

4.5 Additional Components

The device was integrated with a Labsmith HSV448 6000 D power supply and CHI instruments 730D software. The power supply was necessary for the applied potential (the basis of CE). Additionally, our device required integration with a Harvard Apparatus Syringe Pump 22 to clean and prepare the channels for runs. In order to attach the syringe pump, our device was bonded between two glass slides to allow for the syringe pump inlets to be bonded to the glass. The syringe pump was only needed before, between, and after runs, making the integration fairly simple. Another key instrument was the Olympus BX51WI microscope used to visualize flow through the device. The fluorescent bulb on the microscope excited FITC-dextran molecules to induce fluorescence, which the filters on the microscope allowed us to visualize. After assembling the device, several tests were implemented to ensure that the device worked. The first test determined if the decoupler worked properly. A buffer solution was run as a negative control - meaning that the electrode should not show any activity. If the decoupler works, the chemical analyzer will show no significant peaks (generally less than 1 nA). If the decoupler did not work, a peak appeared despite the lack of analyte. The second test was a simple detection limit test where standard solutions of dopamine were run through the device. The

device was able to detect to the mid-nanomolar range, if it did not, then a new device was fabricated. The next step was to check if the device could separate the neuromodulators including the isomers. Thus, the buffer solution with SDS micelles was run through the device to separate the isomers. The chemical analyzer should show two peaks when the isomers successfully separate. As before, this was a positive control to effectively test whether the MEKC element worked.

4.6 Testing Results

We performed various tests throughout the development of our device. This ensured all aspects of the device worked independently before combining all the technology into one cohesive device.

4.6.1 Fluid Control

To ensure we could control the direction of the fluid in the device, we performed testing with FITC-dextran, which glows when excited by the proper wavelength. We applied 1200 volts to the top portion of the T-style injector and success fully drove the solution to the waste well.

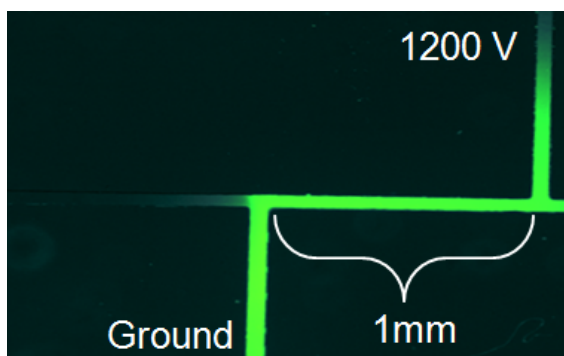

Figure 4.4: Fluid control

4.6.2 Cyclic Voltammetry

Cyclic voltammetry was used as a preliminary test to determine the functionality of the carbon paste electrode. This does not require the device to be sealed and allows the electrode to be tested independently from electroosmotic flow.

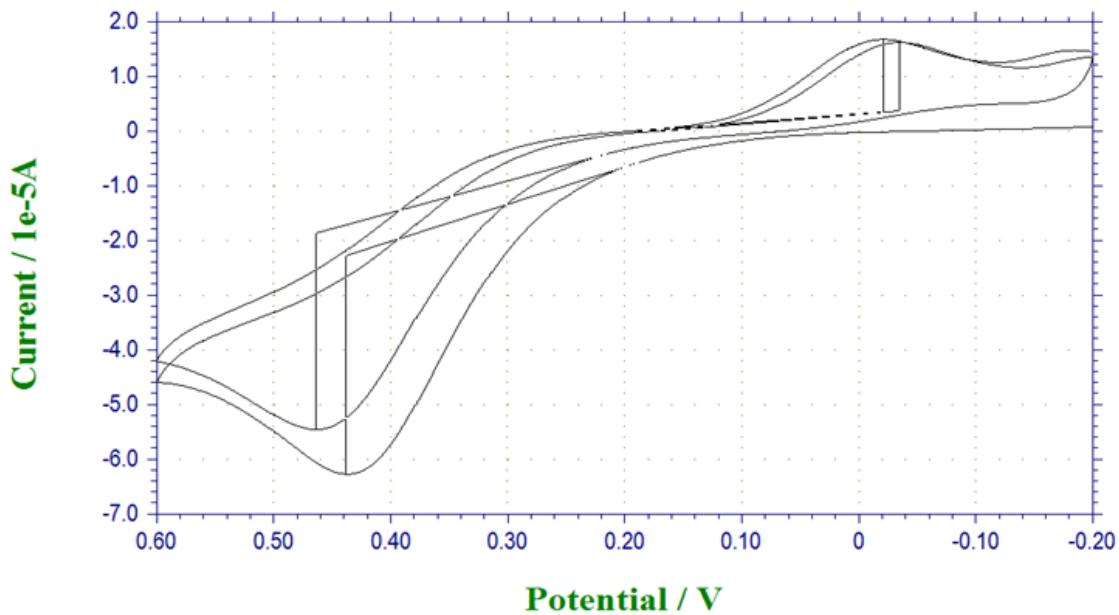

Figure 4.5: Cyclic voltammetry results of a 10mM solution of dopamine

4.6.3 Amperometric Detection

Amperometric detection of a 10mM dopamine test solution. This was done without the decoupler so there is some interference with the applied voltage.

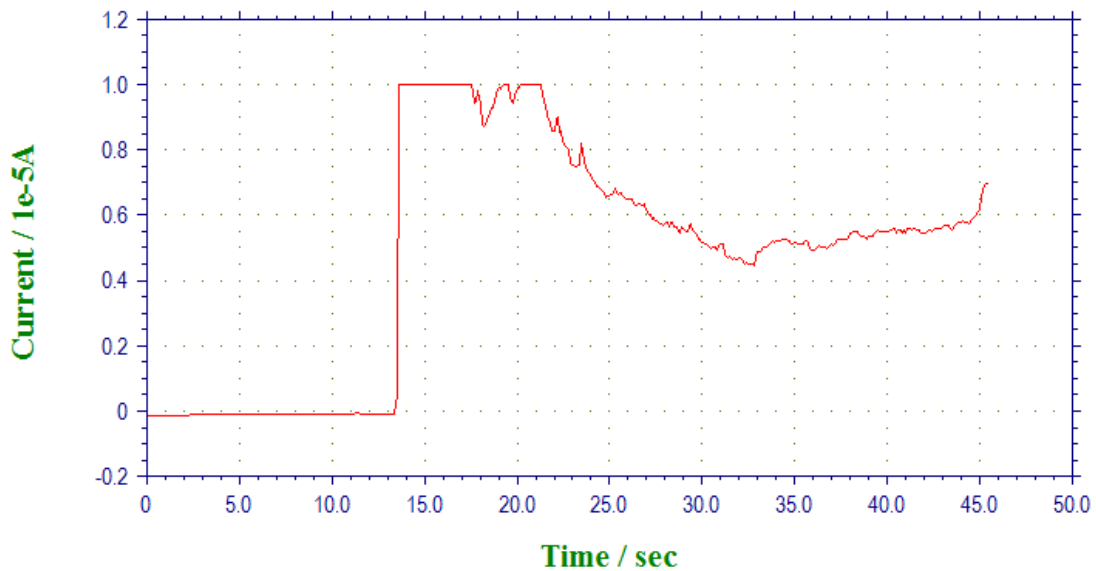

Figure 4.6: Amperometric detection of a 10mM test solution of dopamine. 1000 volts were applied at 13 seconds

Chapter 5

Cost Analysis

We were awarded \$1,500 from the Santa Clara University School of Engineering. The majority of our budget went towards purchasing equipment to help with the fabrication of our devices. We were able to stay within our given budget. The most expensive component of the device is the palladium decoupler. We felt that in order to meet the customer needs we needed palladium as the material. A detailed table outlining our materials and equipment costs can be found in the appendix.

Chapter 6

Publishing Plan

We need to continue to test the device and gather adequate data. If we can find the device to be fully functional and perform to the customer needs we may peruse publishing the research obtained from this project. A group will be continuing the project in the coming year.

Chapter 7

Engineering Standards and Realistic Constraints

The inclusion of a carbon paste electrode was largely to maintain economic constraints. Carbon paste was inexpensive, well-documented, and easy to incorporate into our device. Since our team operated within a strict budget, we wanted to maintain device performance, but limit unnecessary additions to the device. We consulted with faculty involved with the project to ensure we delivered exactly what they needed and reduced any excessive features. Sustainability, environmental, and safety concerns were addressed early on when choosing components for our device. We wanted to ensure that our device would be affordable as well as durable enough to withstand multiple uses and maintain accurate detection. The design minimized toxicity it may release during operation or byproducts released in breakdown. The components we used do not pose any serious risk to any persons using it or the environment. Manufacturability was addressed through revisions and device testing. We aimed to make a device that met the customers needs and also maintained aesthetic excellence. We already altered our device from its original design to include glass slides on both sides to increase durability as well as enhance the aesthetic value.

Chapter 8

Summary and Conclusions

Our team designed a microfluidic device to aid the Physics Department with their experiments involving the Jonah crab. The interview with Kim, Suljak, and Birmingham provided specific goals to satisfy our customers needs. Our device must have mid-nanomolar detection capabilities, small sample size, and be able to separate the two structural isomers while still maintaining affordability. To meet these goals a PDMS based device was designed to utilize AD in conjunction with a carbon paste electrode as well as MEKC to quantify and isolate bioamines. Fabrication of the device was the main accomplishment for the year. We were able to successfully incorporate all the technology that goes into our device, while creating a detailed fabrication protocol. We found ways to overcome many fabrication challenges and streamline the production of the device. This will help the individuals continuing the project in the coming year so they can focus on characterization of the device and integration with the collaborating physics and chemistry departments.

Chapter 9

Bibliography

1. Suljak, S., & Birmingham, J. (2010). Investigating the role of neurohemal biogenic amines in shaping stomatogastric motor programs of the crab *Cancer borealis*. Research proposal document, Chemistry, Santa Clara University, Santa Clara,

2. Alvarez, Mario, Teresa Fernandez-Abdul, and Agustin Costa-Garcia. "Amperometric detector designs for capillary electrophoresis microchips." *Journal of Chromatography*. (2006): 291-299. Print. This article is vital to our project because it details how to construct a sensor in a device with electrochemical detection capabilities. It also describes how to integrate a palladium decoupler into the device, which we are also doing in our device.

3. Gahnim, M.H., and M.Z. Abdullah. "Integrating amperometric detection with electrophoresis microchip devices for biochemical assays: Recent developments." *Talanta*. (2011): 28-34. Print. This article is essential during the design process of our device because it details the challenges and benefits of microchip capillary electrophoresis device that use amperometric detection.

4. Holcomb, Ryan, James Kraly, and Charles Henry. "Electrode array detector for microchip capillary electrophoresis." *Royal Society of Chemistry*. (2008): n. page. Print. This article details the use of multiple electrodes within a microfluidic device. Our group will test both multi-electrode configuration and single electrode design to determine which is better suited for our customers.

5. Matysik, Frank-Michael. Advances in amperometric and conductometric detection in capillary and chip-based electrophoresis. *Microchim Acta*. 160 (2008): 114.

6. Sameenoi, Yupaporn, Meghan Mensack, Kanokporn Boonsong, Rebecca Ewing, Wijitar Dungchai, Orawan Chailapakul, Donald Cropek, and Charles Henry. "Poly(dimethylsiloxane) cross-linked carbon paste electrodes for microfluidic electrochemical sensing." *Analyst* 136.15 (2011): 3177-3184. Academic Search Complete. Web. 16 Oct. 2012. This article is necessary for our project because it details how to design a carbon paste electrode, which we are also using in our device. The article also describes integrating carbon

nanotubes and detecting dopamine with a microfluidic device.

7. Ream, Paula, Steven Suljak, Andrew Ewing, and Kyung-An Han. "Micellar Electrokinetic Capillary Chromatography-Electrochemical Detection for Analysis of Biogenic Amines in *Drosophila melanogaster*." *Analytic Chemistry*. (2003): 3972-3978. Print. Our device will use both micellar kinetic chromatography and amperometric detection to separate and quantify bioamines. This article detailed similar research involving the fruit fly, *Drosophila melanogaster*.

8. Paxon, Tracy L., Paula R. Powell, Hyun-Gwan Lee, Kyung-An Han, and Andrew G. Ewing. Micro-column Separation of Amine Metabolites in the Fruit Fly. *Analytical Chemistry*. 77 (2005): 5349-5355.

9. Koa, Yu-Yen, Kung-Tien Liub, Ming-Feng Huanga, Tai-Chia Chiuc, Huan-Tsung Changa. Analysis of amino acids and biogenic amines in breast cancer cells by capillary electrophoresis using polymer solutions containing sodium dodecyl sulfate. *Journal of Chromatography A*. 1217 (2010): 582587.

10. Gonzalez, Carlos F., Donald M. Crotek, Charles S. Henry. Photopatternable Carbon Electrodes for Chip-Based Electrochemical Detection. *Electroanalysis*. 29.19 (2009):2171-4.

11. Del Campo, A. and C. Greiner. SU-8: a photoresist for high-aspect-ratio and 3D submicron lithography. *Journal of Micromechanics and Microengineering*. 17 (2007): R81R95.

12. Yoon-Bo Shim, et al. "Separation And Simultaneous Detection Of Anticancer Drugs In A Microfluidic Device With An Amperometric Biosensor." *Biosensors & Bioelectronics* 28.1 (2011): 326-332. Academic Search Complete. Web. 16 Oct. 2012. This article is relevant because it discusses amperometric detection (AD), which our group is using in conjunction with our device. As part of our goal to achieve lower limits of detection, we need to use AD since this method of detection is more sensitive than some of the alternatives such as absorbance or cyclic voltammetry. It also discusses its application as a biosensor in a microfluidic device.

13. Changqing Xu, et al. "Sealing SU-8 Microfluidic Channels Using PDMS." *Biomicrofluidics* 5.4 (2011): 046503. Academic Search Complete. Web. 16 Oct. 2012. This article is relevant because it discusses fabrication techniques and technologies that our project uses to fabricate the device we are building.

14. Fingerman, Milton, Rachakonda Nagabhushanam, Rachakonda Sarojini, and Palla S. Reddy. Biogenic Amines In Crustaceans: Identification, Localization, and Roles. *Journal of Crustacean Biology*. 14.3 (1994): 413-437.

Appendices

Appendix A

Interviews

Dr. Kim, Santa Clara University Department of Bioengineering, October 2012

Prompt	Response
Typical Uses for Microfluidic Device	Diagnostic tools, cell sorting, cell arrays
Microfluidic device use for chemical detection	Easy integration, easy to add pretreatments, multiple modules in one chip possible
Weaknesses in microfluidic device	Requires large scale equipment to function, other components not miniaturized
Challenges of project	Correct alignment of sensor and channel, repeatability of results, combining detection and flow, placement of decoupler and sensor
Other uses for our device	Identifying samples, pharmaceutical application, sorting amino acids

Table A.1: Kim Interview

Dr. Suljak, Santa Clara University Department of Chemistry, October 2012

Prompt	Response
What device(s) are you using currently for the detection of the neuromodulators of interest? What is the model and how much did it cost?	1) Thermo LC/MS, model: LCQ Fleet; cost: few \$100,000. 2) Beckmann Coulter CE with MEKC, model: MDQ; cost: \$100,000
What are the specifications in terms of strengths, detection limits, cost, etc.?	1) ESI source with Ion trap analyzer. Strong identifier of molecules; mid micromolar sensitivity. Tandem MS/MS capabilities 2) MEKC with absorbance detection. Absorbance is simple; only mid-micromolar range. Successful separations of dopamine and octopamine.
What are the weaknesses of the device(s) that you are using?	Low sensitivities, large sample sizes.
What requirements or specifications should we ideally meet in terms of detection limits, cost, etc.?	Mid-nanomolar detection, smaller sample sizes, MEKC for isomers, cheap, inert

Table A.2: Suljak Interview

Dr. Birmingham, Santa Clara University Department of Physics, October 2012

Prompt	Response
Goals of research	Characterize presence and actions of bioamines in <i>Cancer borealis</i>
Current method/device	LC/MS in conjunction with microdialysis
Current detection capabilities	1 μ M
Desired features	Increased sensitivity (at least by factor of 10 greater); distinguish structural isomers
Requirements	Finalized product within a year; Increased sensitivity and reproducible behavior; \$100 per device (one time use)

Table A.3: Birmingham Interview

Appendix B

Solidworks Designs

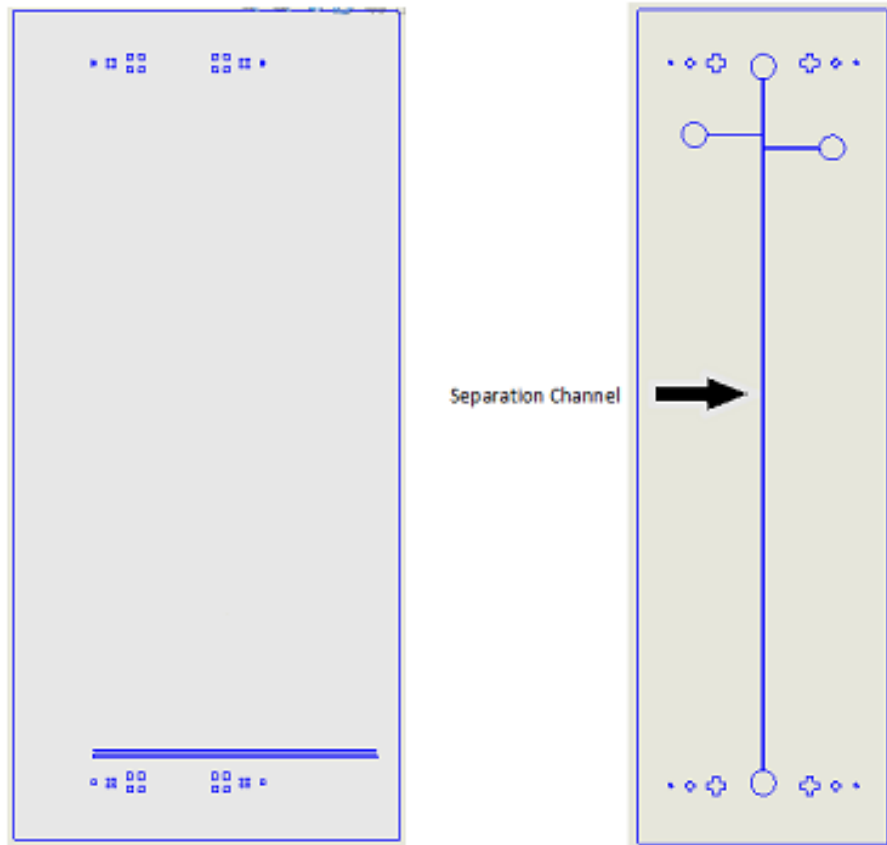

Figure B.1: Electrode design (bottom of device) and Channel design (top of device)

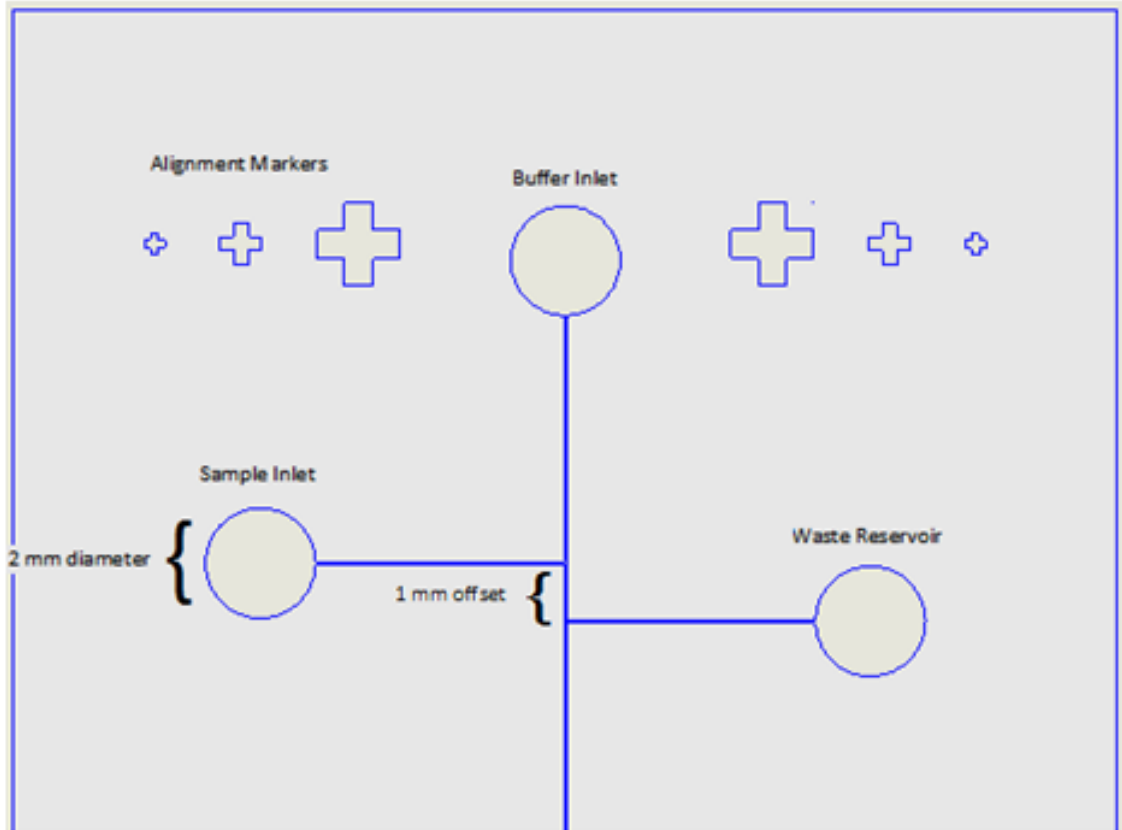

Figure B.2: Close view of the T-section of the channel design

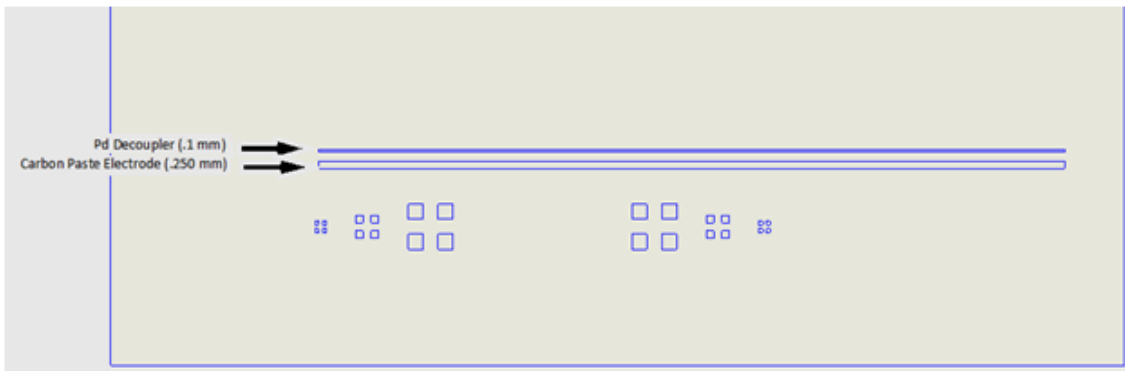

Figure B.3: Close view of the electrode and decoupler

Appendix C

Budget

Item	Use	Quantity	Cost (\$)
PDMS Mix	Forms Device	2 x 1.1lbs, 998g	\$118.32
Carbon Nanotubes	Enhances Working Electrode	3g	\$191.60
Pressure gauge	Tells pressure	1	\$600.00
Palladium decoupler (.05mm d)	Disrupts Applied Potential	.5m	\$120.00
Epoxy	Securing wires/Insulation	1	\$49.00
Hole Punch	Forms well for solutions	2	\$15.00
Scalpel	Cuts device to size	1 pack	\$7.00
Molds	Gives device its form	3	\$370.00
Tubing	Used during testing	1m	\$7.67
	Expenses	Total	-\$1,478.59
Engineering School Funding	Income		\$1,500.00

Table C.1: Budget

Appendix D

Procedure

Making the microfluidic device

The PDMS portion of the device:

Materials:

Weighing Boat(s)

Acetone

Sylgard 184 10:1 PDMS Kit

Spatula

Preparation:

1. Turn the oven on and set to 75 C.
2. Clean wafers or device mold with acetone, do not sonicate.
3. Wrap mold in foil to prevent PDMS from pouring over the edges.

Device fabrication procedure:

1. Weigh out 2 grams of PDMS curing agent in a small weighing boat or beaker. Tare the container with curing agent. Then add 20 grams of PDMS base. Mix using a spatula for three minutes or until the base and binder are thoroughly mixed.
2. Pour the curing agent and base mixture onto the prepared device molds. Minimize bubble formation by holding the container close to the mold. Use a spatula to transfer the remaining mixture to the mold.
3. Degas the PDMS on the mold for 10 minutes. Using compressed air or nitrogen, gently remove all remaining bubbles. If compressed air or nitrogen are not available, degas PDMS for an hour or until all bubbles are removed.
4. Place the device gently into the oven - set at 75 C - for a minimum of two hours. Longer times may be used, but make sure not to over-cure the PDMS.
5. After curing the PDMS in the oven, remove the mold from the oven and allow to cool until safe to touch. Using a scalpel remove the excess PDMS and foil so that the solidified PDMS can be peeled off the mold. Peel off the PDMS containing the desired features and place on a clean surface. Use a scalpel to cut out the device design.

The electrode portion of the device:

Materials:

Mineral Oil

Weighing Boat(s)
PDMS
Scotch Tape
Microscope
Carbon Nanotubes
Graphite Powder
Spatula
Pottery Tool

Electrode fabrication procedure:

1. Measure 0.100 g of mineral oil in a weighing boat. Note: mineral oil is non-viscous and may slowly leak out of the syringe. Tare the weighing boat containing the mineral oil. Measure 0.100 g of PDMS in the same weighing boat. Excess PDMS and mineral oil up to .040 g combined is encouraged to create a more consistent electrode texture.
2. Measure 0.100 g of graphite in a different weighing boat. Tare the weighing boat containing the graphite. Measure 0.100 g of carbon nanotubes.
3. Pour the 0.200 g graphite-carbon nanotube mixture into the weighing boat containing the mineral oil and PDMS. Mix well until the materials have a paste-like consistency.
4. Using a scalpel, remove the PDMS with the electrode features. Place the PDMS on a clean, transparent case. Using Scotch Tape, cover the decoupler channel. Also tape below the electrode channel leaving a small portion of the device with the electrode channel exposed to air. Use a microscope to ensure that the decoupler channel has been satisfactorily covered.
5. Then, with the art tool, screen print the electrode paste by trying to apply even pressure across the channel. Remove the Scotch Tape covering the decoupler. To remove the excess surrounding carbon paste, liberally use tape applying light pressure.

Decoupler Installment:

Materials:
Scotch Tape
Palladium Wire 50 micrometer radius
Quick Dry 5 Minute Epoxy

Installment Procedure:

1. Obtain 0.75 inches of Pd wire. Tape the left side of the wire onto the microscope slide. Pull the wire taut and place in the decoupler channel.
2. Use the microscope to ensure successful placement of the Pd wire. Adjust accordingly.
3. Once the wire has been successfully placed in the channel, apply 5 minute epoxy to both sides of the channel. Do not block the middle of the wire where the separation channel crosses or the edges (since the Pd wire needs to be electrically connected).
4. After the epoxy sets (about 5 minutes), tape off the excess epoxy to create a smooth surface for bonding.

Bonding portion of device:

Materials:
PDC-001 Harrick Plasma Cleaner
Purple Hole Punch
Clean Glass Slide

Preparation:

Use the (purple) hole punch to create inlets to the reservoirs. Punch the holes from the side with the features to the exterior side. Turn on plasma cleaner and allow the instrument to warm up for 1 min before use. Ensure that all materials placed inside the plasma cleaning chamber are not wet.

Bonding procedure:

1. Place the PDMS halves in the chamber with the features facing up. Close the chamber door and close all valves and turn the vacuum on. Bring the chamber to about 500 millitorr and purge the chamber by allowing a small amount of air into the chamber. This may have to be done several times to obtain relatively modest pressure increases in the chamber. Once the pressure increase is modest, vacuum to 600 millitorr and allow the chamber pressure to rise to 750 millitorr.
2. When a stable chamber pressure is achieved expose the PDMS to plasma for 15 seconds on the medium setting. Note the color of the plasma. A pink-purple color is expected.
3. After the exposure time, vent the chamber until the door releases.
4. Take the two halves and lay them on top of one another to bond them together. You may see a wave confirming that bonding is taking place.
5. Repeat steps 1 through 3 using the bonded device and a glass slide. When bonding the glass to the PDMS halves, ensure that the inlets are not covered and the reservoir is downstream from the electrode. Once the glass is bonded to the exterior of the PDMS with electrode features, gently clip the edges of the device with office clips. After the clips are secured, place the device in an oven set to 71 C and allow to sit for 10 minutes to strengthen the bond.

Wire attachment portion of device:

Materials:

Copper Wire

Silver/Silver Chloride Ink

Quick Dry 5 Minute Epoxy

Wire attachment procedure:

1. Using silver/silver chloride ink connect a copper wire to the carbon paste electrode. Be careful not to electrically connect the decoupler with the electrode. Then, place silver ink on the decoupler. Again, do not allow the ink to border both the electrode and decoupler. Allow this to dry for several hours.
2. Place epoxy over the silver/silver chloride and wire connection to secure the wire. Also place epoxy on both sides where the decoupler and electrode channels come out. Allow to set. The device is now fabricated and testing can begin.

Appendix E

Schedule

Fall Quarter 2012	Plan
Week 4	Plan budgeting, components and equipment for device
Week 7	Receive Budget Approval
Week 8	Acquire SU-8 molds
Week 9	Conceptual Design Review

Table E.1: Fall 2012

Winter Quarter 2013	Plan
Week 1	Fabrication Begin
Week 3	Test decoupler placement
Week 6	Test Plasma bonder

Table E.2: Winter 2013

Spring Quarter 2013	Plan
Week 1	Test with fluid in device
Week 4	Finalize presentation
Week 10	Finalize thesis

Table E.3: Spring 2013